

FO converters - PSI-MOS-PROFIB/FO 660 E - 2708290

Please be informed that the data shown in this PDF Document is generated from our Online Catalog. Please find the complete data in the user's documentation. Our General Terms of Use for Downloads are valid (<http://phoenixcontact.com/download>)



FO converter with integrated optical diagnostics, alarm contact, for PROFIBUS up to 12 Mbps, terminal device with one FO interface (FSMA), 660 nm, for polymer/PCF fiber cable

Your advantages

- ✓ Can be combined with the PSI copper repeater in a modular way using DIN rail connectors
- ✓ Supply voltage and data signals routed through via DIN rail connectors
- ✓ Connections can be plugged in using a COMBICON screw terminal block
- ✓ Automatic data rate detection or fixed data rate setting via DIP switches
- ✓ Redundant power supply possible by means of optional system power supply unit
- ✓ High-quality electrical isolation between all interfaces (PROFIBUS // fiber optic ports // power supply // DIN rail connector)
- ✓ Approved for use in zone 2
- ✓ Intrinsically safe fiber optic interface (Ex op is) for direct connection to devices in zone 1
- ✓ Floating switch contact for leading alarm generation in relation to critical fiber optic paths
- ✓ Integrated optical diagnostics for continuous monitoring of fiber optic paths
- ✓ Suitable for all data rates up to 12 Mbps
- ✓ Bit retiming for any cascading depth
- ✓ Shipbuilding approval in accordance with DNV GL



Key Commercial Data

Packing unit	1 pc
GTIN	
GTIN	4017918973995
Weight per Piece (excluding packing)	219.000 g
Custom tariff number	85176200
Country of origin	Germany

FO converters - PSI-MOS-PROFIB/FO 660 E - 2708290

Technical data

Note

Utilization restriction	EMC: class A product, see manufacturer's declaration in the download area
-------------------------	---

Dimensions

Width	35 mm
Height	99 mm
Depth	106 mm

Ambient conditions

Ambient temperature (operation)	-20 °C ... 60 °C
Ambient temperature (storage/transport)	-40 °C ... 85 °C
Permissible humidity (operation)	30 % ... 95 % (non-condensing)
Altitude	≤ 5000 m (For restrictions, see the manufacturer's declaration for altitude operation)
Degree of protection	IP20
Noise immunity	EN 61000-6-2:2005

General

Bit delay	≤ 1 bit
Bit distortion, input	± 35 % (permitted)
Bit distortion, output	< 6.25 %
Electrical isolation	VCC // RS-485
Test voltage data interface/power supply	1.5 kV _{rms} (50 Hz, 1 min.)
Electromagnetic compatibility	Conformance with EMC Directive 2014/30/EU
Noise emission	EN 55011
Net weight	241.9 g
Housing material	PA 6.6-FR
Color	green
MTBF	324 Years (Telcordia standard, 25°C temperature, 21% operating cycle (5 days a week, 8 hours a day))
	70 Years (Telcordia standard, 40°C temperature, 34.25% operating cycle (5 days a week, 12 hours a day))
MTTF	243 Years (SN 29500 standard, temperature 25 °C, operating cycle 21 % (5 days a week, 8 hours a day))
	178 Years (SN 29500 standard, temperature 40 °C, operating cycle 34.25 % (5 days a week, 12 hours a day))
	110 Years (SN 29500 standard, temperature 40 °C, operating cycle 100 % (7 days a week, 24 hours a day))

Power supply

Nominal supply voltage	24 V DC (With UL approval)
------------------------	----------------------------

FO converters - PSI-MOS-PROFIB/FO 660 E - 2708290

Technical data

Power supply

Supply voltage range	18 V DC ... 30 V DC
Max. current consumption	130 mA
Typical current consumption	100 mA (24 V DC)
Connection method	COMBICON plug-in screw terminal block

Serial interface

Interface 1	PROFIBUS acc. to IEC 61158, RS-485 2-wire, half duplex, automatic control
Interface	PROFIBUS
Operating mode	Semi-duplex
Connection method	D-SUB-9 female connector
File format/coding	UART (11 Bit, NRZ)
Data direction switching	Automatic control
Transmission medium	Copper
Transmission length	≤ 1200 m (depending on the data rate, with shielded, twisted pair data cable)
Conductor cross section solid min.	0.2 mm ²
Conductor cross section solid max.	2.5 mm ²
Conductor cross section flexible min.	0.2 mm ²
Conductor cross section flexible max.	2.5 mm ²
Conductor cross section AWG min.	24
Conductor cross section AWG max.	14
Serial transmission speed	≤ 12 Mbps

Optical interface FO

Transmit capacity, minimum	-3 dBm (980/1000 μm)
	-15.4 dBm (200/230 μm)
Minimum receiver sensitivity	-30 dBm
Overrange receiver	-3 dBm (980/1000 μm)
Wavelength	660 nm
Transmission length incl. 3 dB system reserve	70 m (With F-P 980/1000 230 dB/km with quick mounting connector)
	400 m (With F-K 200/230 10 dB/km with quick mounting connector)
Transmission medium	Polymer fiber
	PCF fiber
Transmission protocol	Protocol-transparent to the RS-485 interface
Connection method	F-SMA

Digital outputs

Output name	Relay output
Output description	Alarm output

FO converters - PSI-MOS-PROFIB/FO 660 E - 2708290

Technical data

Digital outputs

Number of outputs	1
Maximum switching voltage	60 V DC
	42 V AC
Limiting continuous current	0.46 A

Conformance/approvals

Designation	CE
Identification	CE-compliant
Designation	EAC
Identification	EAC
Designation	ATEX
Identification	# II 3 G Ex nA nC IIC T4 Gc X
Additional text	Please follow the special installation instructions in the documentation!
Designation	ATEX
Identification	# II (2) G [Ex op is Gb] IIC
	# II (2) D [Ex op is Db] IIIC
Certificate	PTB 06 ATEX 2042 U
Additional text	Please follow the special installation instructions in the documentation!
Designation	UL, USA/Canada
Identification	Class I, Zone 2, AEx nc IIC T5
	Class I, Zone 2, Ex nC nL IIC T5 X
	Class I, Div. 2, Groups A, B, C, D
Designation	PTB
	PROFIBUS approval
Additional text	PROFIBUS-Center Netherlands
Designation	Corrosive gas test
Identification	ISA-S71.04-1985 G3 Harsh Group A
Designation	Shipbuilding
Identification	DNV GL
Temperature	B
Humidity	A
Vibration	A
EMC	B
Enclosure	Required protection according to the Rules shall be provided upon installation on board

Standards and Regulations

Electromagnetic compatibility	Conformance with EMC Directive 2014/30/EU
Type of test	Vibration resistance in acc. with EN 60068-2-6/IEC 60068-2-6

FO converters - PSI-MOS-PROFIB/FO 660 E - 2708290

Technical data

Standards and Regulations

Test result	5g, 10...150 Hz, 2.5 h, in XYZ direction
Type of test	Shock in acc. with EN 60068-2-27/IEC 60068-2-27
Test result	15g, 11 ms period, half-sine shock pulse
Noise emission	EN 55011
Noise immunity	EN 61000-6-2:2005
Free from substances that could impair the application of coating	according to P-VW 3.10.7 57 65 0 VW-AUDI-Seat central standard
Connection in acc. with standard	CUL
Standards/regulations	EN 61000-4-2
Contact discharge	± 6 kV
Standards/regulations	EN 61000-4-3
	EN 61000-4-4
Comments	Criterion B
Standards/regulations	EN 61000-4-5
Signal	± 1 kV
Standards/regulations	EN 55011
	EN 61000-4-6
Shock	15g in all directions in acc. with IEC 60068-2-27
Vibration (operation)	in acc. with IEC 60068-2-6: 5g, 150 Hz

Environmental Product Compliance

REACH SVHC	Lead 7439-92-1
China RoHS	Environmentally Friendly Use Period = 50
	For details about hazardous substances go to tab "Downloads", Category "Manufacturer's declaration"

Drawings

FO converters - PSI-MOS-PROFIB/FO 660 E - 2708290

Application drawing

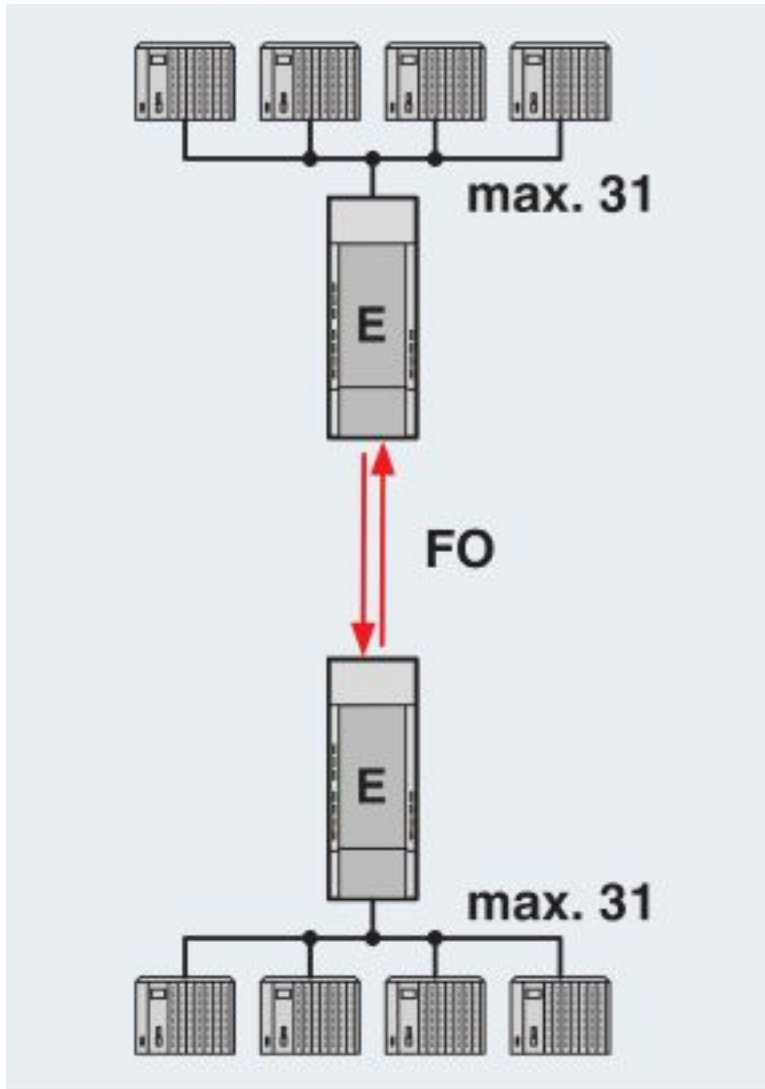

Point-to-point connection

FO converters - PSI-MOS-PROFIB/FO 660 E - 2708290

Application drawing

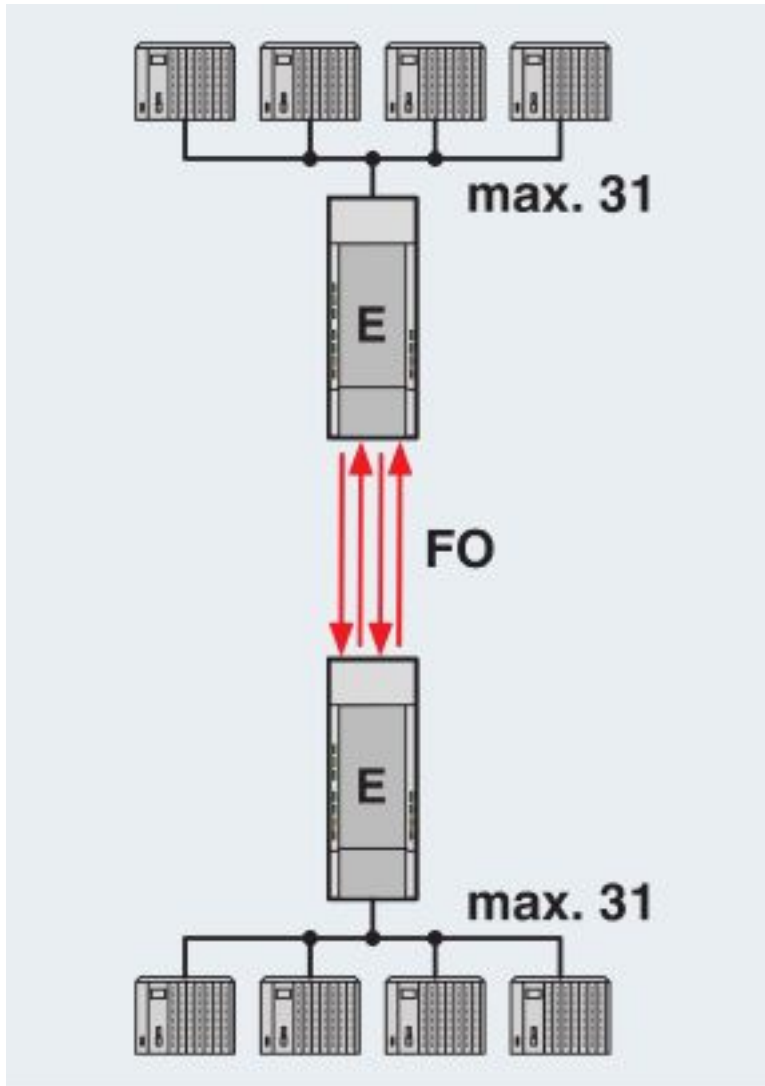

Redundant point-to-point connection

FO converters - PSI-MOS-PROFIB/FO 660 E - 2708290

Application drawing

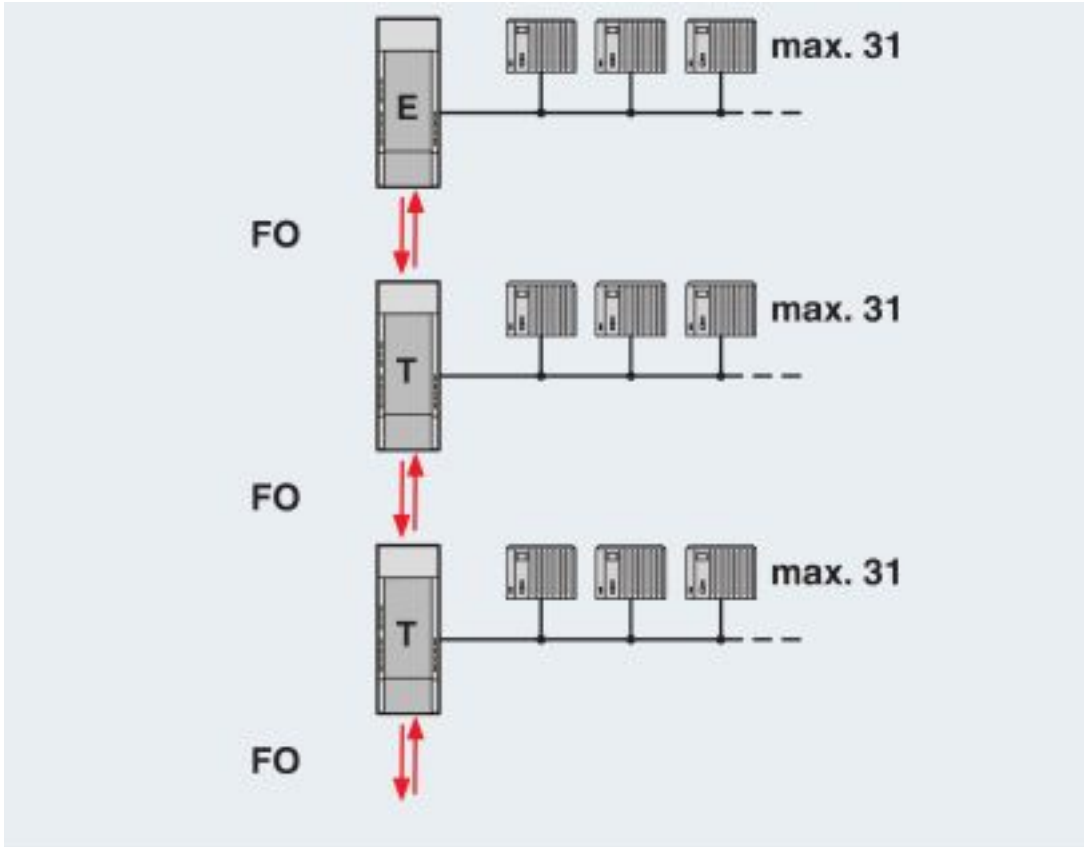

Line structure

FO converters - PSI-MOS-PROFIB/FO 660 E - 2708290

Application drawing

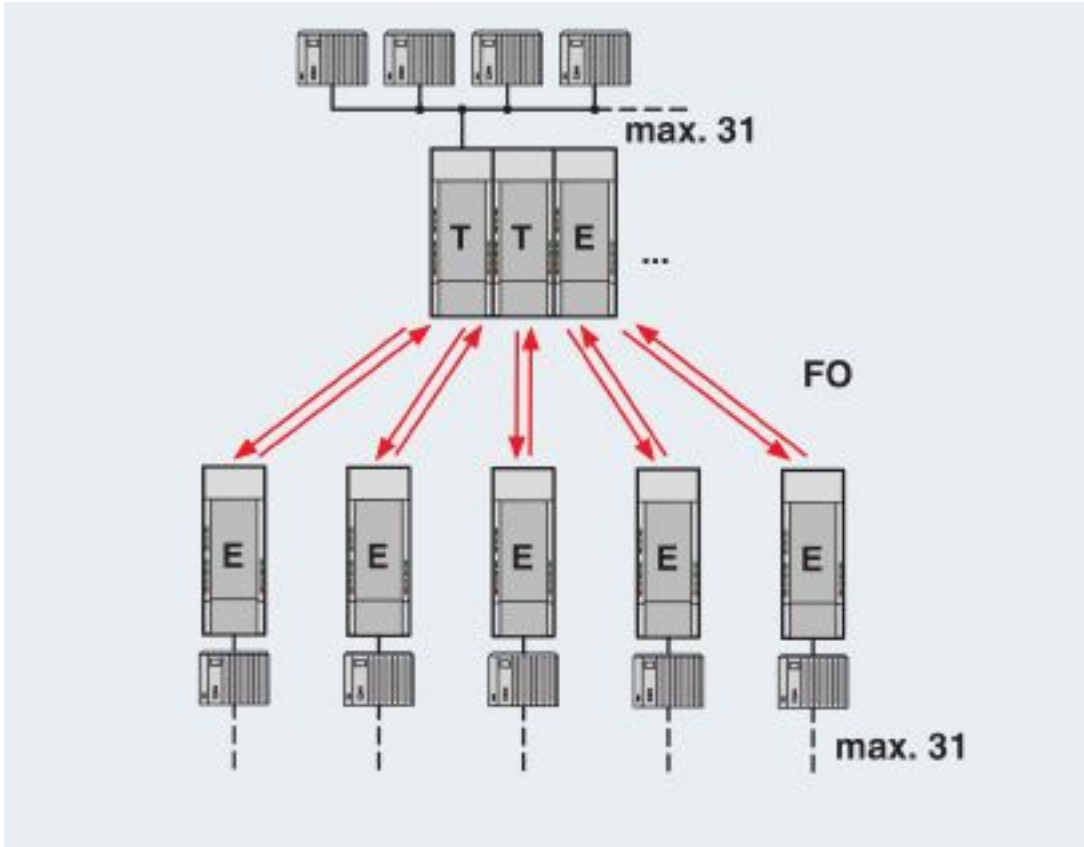

Star structure

FO converters - PSI-MOS-PROFIB/FO 660 E - 2708290

Application drawing

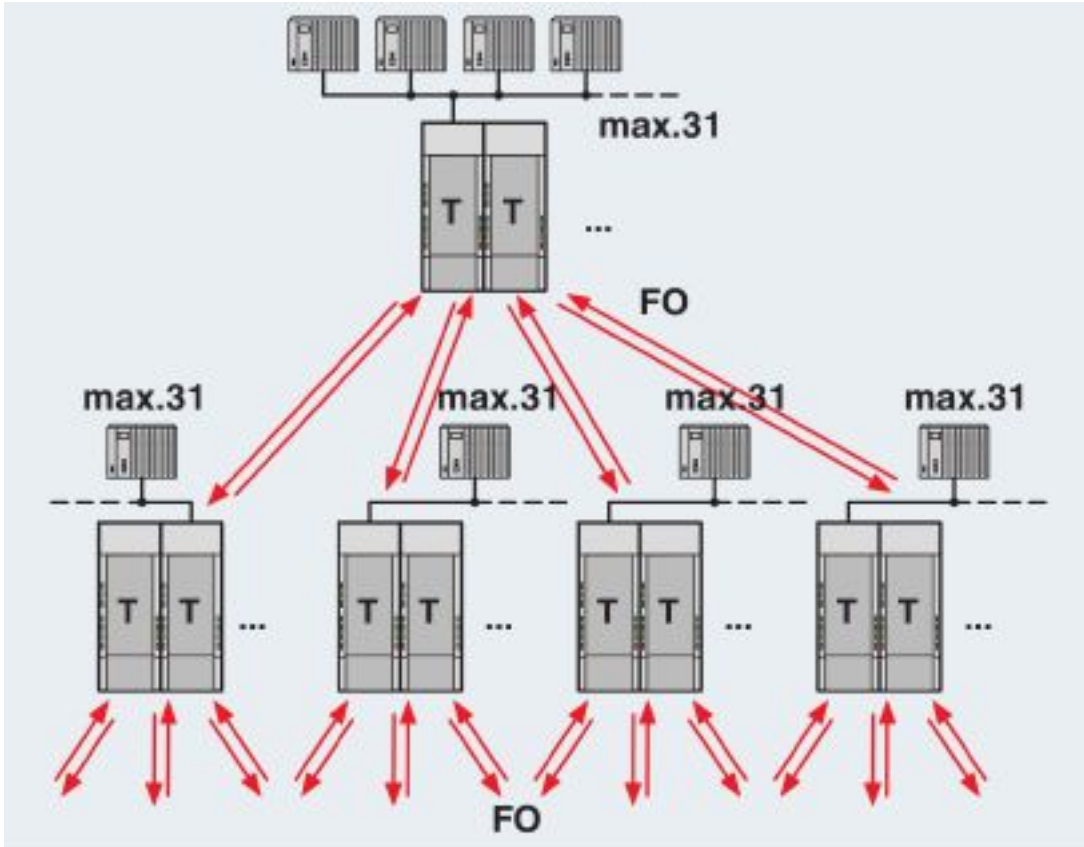

Tree structure

FO converters - PSI-MOS-PROFIB/FO 660 E - 2708290

Application drawing

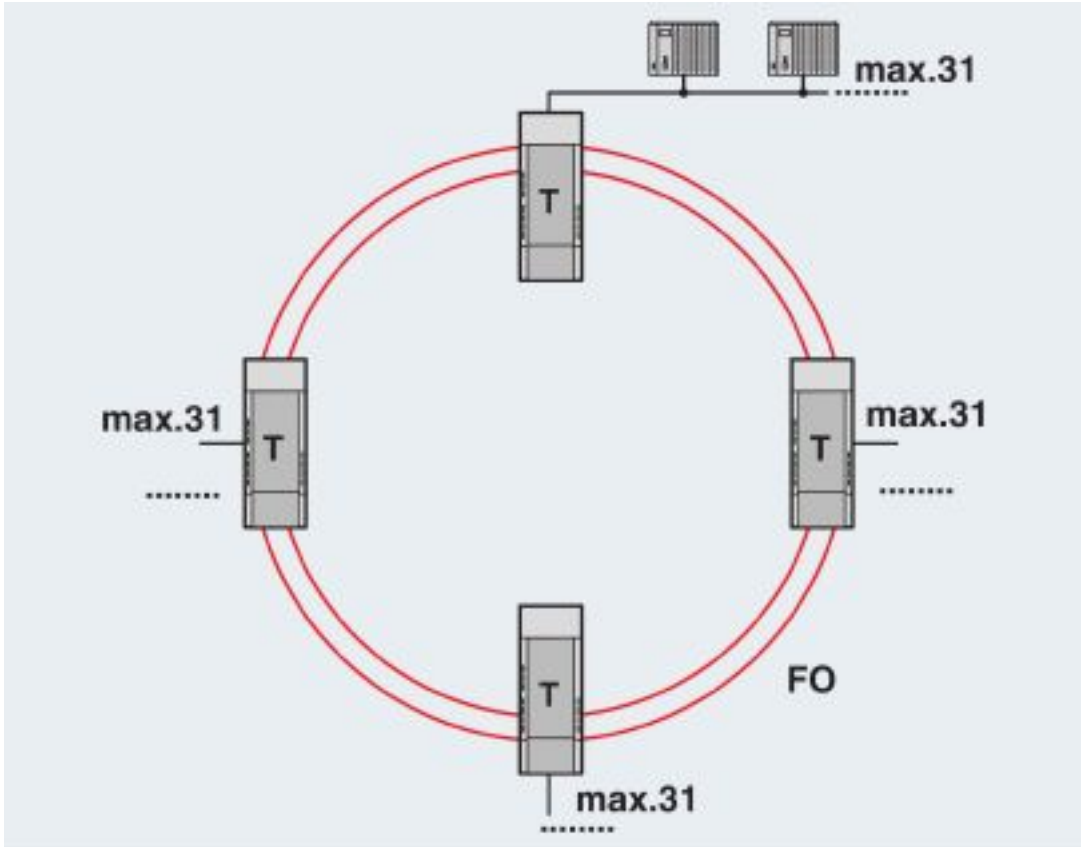

Redundant FO ring

Application drawing

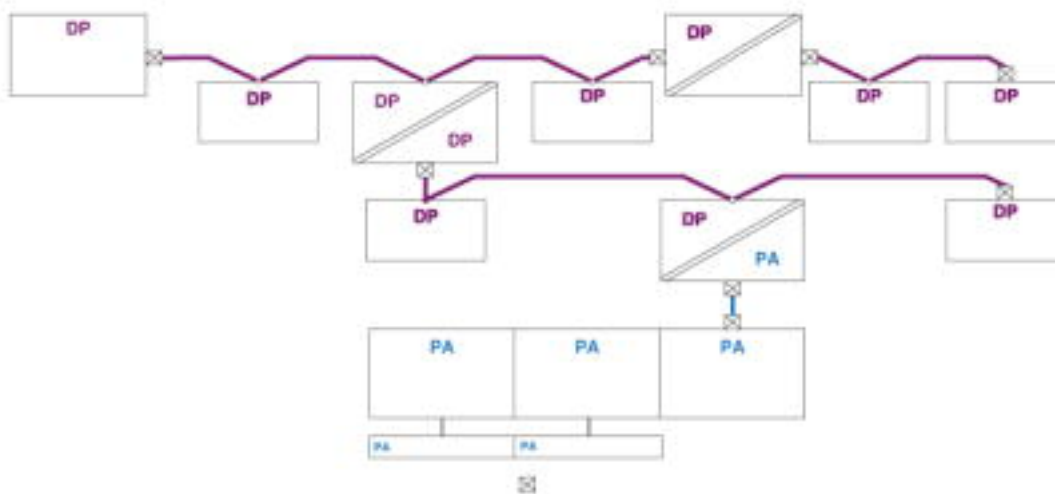

FO converters - PSI-MOS-PROFIB/FO 660 E - 2708290

Classifications

eCl@ss

eCl@ss 4.0	27230200
eCl@ss 4.1	27230200
eCl@ss 5.0	27230200
eCl@ss 5.1	27230200
eCl@ss 6.0	19179200
eCl@ss 7.0	19179290
eCl@ss 8.0	19179290
eCl@ss 9.0	19170114

ETIM

ETIM 2.0	EC001423
ETIM 3.0	EC001423
ETIM 4.0	EC001423
ETIM 5.0	EC000310
ETIM 6.0	EC001467
ETIM 7.0	EC001467

UNSPSC

UNSPSC 6.01	30211506
UNSPSC 7.0901	39121008
UNSPSC 11	39121008
UNSPSC 12.01	39121008
UNSPSC 13.2	43222604

Approvals

Approvals

Approvals

DNV GL / UL Recognized / cUL Recognized / EAC / cULus Recognized

Ex Approvals

UL Listed / cUL Listed / null / null / cULus Listed

Approval details

FO converters - PSI-MOS-PROFIB/FO 660 E - 2708290

Approvals

DNV GL		https://approvalfinder.dnvgl.com/	TAA00001KR
--------	--	---	------------

UL Recognized		http://database.ul.com/cgi-bin/XYV/template/LISEXT/1FRAME/index.htm	FILE E 238705
---------------	--	---	---------------

cUL Recognized		http://database.ul.com/cgi-bin/XYV/template/LISEXT/1FRAME/index.htm	FILE E 238705
----------------	--	---	---------------

EAC			EAC-Zulassung
-----	--	--	---------------

cULus Recognized			
------------------	--	--	--

Accessories

Accessories

Adapter

Connection distributor - PSM PTK - 2760623



Passive RS-485 T-distributor, fitted with one 9-pin D-SUB pin strip and two 9-pin D-SUB socket strips

Connection distributor - PSM PTK-4 - 2799364



Passive RS-485 T-distributor, fitted with one 9-pin D-SUB pin strip and five 9-pin D-SUB socket strips

FO converters - PSI-MOS-PROFIB/FO 660 E - 2708290

Accessories

Data cable by the meter

FO cable - PSM-LWL-KDHEAVY-980/1000 - 2744319



Polymer fiber cable, duplex 980 μm /1000 μm , medium-weight version for installation in stationary systems and machines, by the meter without male connector

FO cable - PSM-LWL-RUGGED-980/1000 - 2744322



Polymer fiber cable, duplex 980 μm /1000 μm , heavy-weight version for installation in stationary systems and machines, by the meter without male connector

FO cable - PSM-LWL-RUGGED-FLEX-980/1000 - 2744335



Polymer fiber cable, duplex 980/1000 μm , heavy-weight, highly flexible version for flexible conduit applications, by the meter, without connector

FO cable - PSM-LWL-HCS-RUGGED-200/230 - 2799885



PCF cable, duplex 200 μm /230 μm , by the meter without male connector, for installation in stationary systems and machines

FO cable - PSM-LWL-HCSO-200/230 - 2799445



PCF cable, duplex 200/230 μm , by the meter, without connector, for outdoor installation

FO converters - PSI-MOS-PROFIB/FO 660 E - 2708290

Accessories

Bus system cable - PSM-CABLE-PROFIB/FC - 2744652



By the meter, Bus system cable, PROFIBUS (12 Mbps), shielded, PVC FR VI/PVC, Violet, 2-wire (1X2XAWG22/1), color single wire: Red, green, cable length: Free entry (1.0 ... 1000.0 m)

Data cable preassembled

FO patch cable - FOC-RUGGED-1012/IP20/... - 2901548



Robust POF installation cable for assembly (IP20 heads only) for installation in stationary systems and machines with individual elements made of polyamide (PE), halogen-free, ozone and UV resistant, with reinforced polyurethane (PUR) outer sheath

FO patch cable - FOC-RUGGED-1012/... - 1402185



rugged POF installation cable for fixed installation in the inner area with individual elements made of highly durable polyamide (PE). Dimensioned for higher requirements in respect of tensile load and lateral pressure, with individual elements made of highly wear-resistant polyamide (PE). The cable is halogen-free, ozone and UV resistant and has a reinforced (PUR) outer sheath.

FO patch cable - FOC-RUGGED-FLEX-1013/IP20/... - 2901549



Highly flexible POF round cable (IP20 heads only) for use in drag chains. Individual elements made from extremely wear-resistant polyamide (PE). The cable is halogen-free, ozone and UV resistant, and has a rugged polyurethane (PUR) outer sheath.

FO patch cable - FOC-RUGGED-FLEX-1013/... - 1402187



Highly flexible POF round cable for use in drag chains for an alternating bending frequency of up to 5 million cycles with individual elements made of highly wear-resistant polyamide (PE). The cable is halogen-free, ozone and UV resistant and has a rugged polyurethane (PUR) outer sheath.

FO converters - PSI-MOS-PROFIB/FO 660 E - 2708290

Accessories

FO patch cable - FOC-KDHEAVY-1011/IP20/... - 2901553



POF installation cable for assembly (IP20 heads only) for installation in stationary systems and machines with individual elements made of polyamide (PE), halogen-free, ozone and UV resistant, with a polyurethane (PUR) outer sheath

FO patch cable - FOC-KDHEAVY-1011/... - 1402188



POF installation cable for fixed installation in the inner area with individual elements made of highly durable polyamide (PE). The cable is halogen-free, ozone and UV resistant and has a rugged polyurethane (PUR) outer sheath.

FO patch cable - FOC-HCS-RUGGED-1014/IP20/... - 2901555



Robust PCF installation cable for assembly (IP20 heads only) for installation in stationary systems and machines, aramid strain relief elements, with individual elements made from FRNC material, halogen-free, ozone and UV resistant, with a polyurethane (PUR) outer sheath

FO patch cable - FOC-HCS-RUGGED-1014/... - 1402191



rugged PCF installation cable for inner areas with highly tear-proof aramid strain-relief elements. Individual elements made from highly flexible FRNC material. The cable is halogen-free, ozone and UV resistant and has a rugged polyurethane (PUR) outer sheath.

FO patch cable - FOC-HCSO-1015/IP20/... - 2901557



Highly rugged PCF round cable (IP20 heads only) for assembly and for outdoor installation with integrated moisture barrier as well as rodent-proof scrim. Individual elements made from highly flexible FRNC material. The wire is ozone and UV resistant with a very rugged polyethylene outer sheath.

Data plug

FO converters - PSI-MOS-PROFIB/FO 660 E - 2708290

Accessories

D-SUB bus connector - SUBCON-PLUS-PROFIB/SC2 - 2708232



D-SUB connector, 9-pos., male connector, cable entry < 35°, bus system: PROFIBUS DP up to 12 Mbps, termination resistor can be switched on via slide switch, pin assignment: 3, 5, 6, 8; screw connection terminal blocks

D-SUB bus connector - SUBCON-PLUS-PROFIB/PG/SC2 - 2708245



D-SUB connector, 9-pos., male connector, cable entry < 35°, bus system: PROFIBUS DP up to 12 Mbps with PG D-SUB socket for connecting a programming device, termination resistor can be switched on via slide switch, pin assignment: 3, 5, 6, 8; screw connection terminal blocks

D-SUB bus connector - SUBCON-PLUS-PROFIB/AX/SC - 2744380



D-SUB connector, 9-pos., male connector, axial version with two cable entries, bus system: PROFIBUS DP up to 12 Mbps, termination resistor can be switched on via slide switch, pin assignment: 3, 5, 6, 8; screw connection terminal blocks

D-SUB bus connector - SUBCON-PLUS-PROFIB/90/PG/SC - 2313708



D-SUB connector, 9-pos., male connector, cable entry < 90°, bus system: PROFIBUS DP up to 12 Mbps with PG D-SUB socket for connecting a programming device, termination resistor can be switched on via slide switch, pin assignment: 3, 5, 6, 8; screw connection terminal blocks

D-SUB bus connector - SUBCON-PLUS-PROFIB/90/PG/IDC - 2313685



D-SUB connector, 9-pos., male connector, cable entry < 90°, bus system: PROFIBUS DP up to 12 Mbps with PG D-SUB socket for connecting a programming device, termination resistor can be switched on via slide switch, pin assignment: 3, 5, 6, 8; IDC terminal block connection

FO converters - PSI-MOS-PROFIB/FO 660 E - 2708290

Accessories

D-SUB bus connector - SUBCON-PLUS-PROFIB/AX/M12 - 2902321



D-SUB plug, 9-pos., pin, assignment: 3, 5, 6, 8; two M12 cable glands (B-coded) under 180° (axial). Bus system: PROFIBUS DP up to 12 Mbps. Termination resistor via separate M12 terminator.

D-SUB bus connector - SUBCON-PLUS-PROFIB/90X/M12 - 2902729



D-SUB plug, 9-pos., pin, assignment: 3, 5, 6, 8; two M12 cable glands (B-coded) under 90°. Bus system: PROFIBUS DP up to 12 Mbps. Termination resistor via separate M12 terminator. Long version; S7-compatible.

D-SUB bus connector - SUBCON-PLUS-PROFIB/90/M12 - 2902318



D-SUB plug, 9-pos., pin, assignment: 3, 5, 6, 8; two M12 cable glands (B-coded) under 90°. Bus system: PROFIBUS DP up to 12 Mbps. Termination resistor via separate M12 terminator.

D-SUB bus connector - SUBCON-PLUS-PROFIB/35/M12 - 2902320



D-SUB plug, 9-pos., pin, assignment: 3, 5, 6, 8; two M12 cable glands (B-coded) under 35°. Bus system: PROFIBUS DP up to 12 Mbps. Termination resistor via separate M12 terminator.

DIN rail connector

DIN rail bus connectors - ME 17,5 TBUS 1,5/ 5-ST-3,81 GN - 2709561



DIN rail connector for DIN rail mounting. Universal for TBUS housing. Gold-plated contacts, 5-pos.

FO converters - PSI-MOS-PROFIB/FO 660 E - 2708290

Accessories

Interface converter

Repeater - PSI-REP-PROFIBUS/12MB - 2708863



Modular repeater for electrical isolation and range increase for PROFIBUS up to 12 Mbps, 4-way isolation, rail-mountable, supply 24 V DC

Repeater - PSM-ME-RS485/RS485-P - 2744429



Repeater, for potential separation and range increase in RS-485 2-wire bus systems, 3-way isolation, rail-mountable

Power supply

Power supply unit - MINI-SYS-PS-100-240AC/24DC/1.5 - 2866983



Primary-switched MINI POWER supply for DIN rail mounting, input: 1-phase, output: 24 V DC/1.5 A

Screwdriver tools

Screwdriver - SZS 0,4X2,5 VDE - 1205037



Screwdriver, slot-headed, VDE insulated, size: 0.4 x 2.5 x 80 mm, 2-component grip, with non-slip grip

Terminal resistor

FO converters - PSI-MOS-PROFIB/FO 660 E - 2708290

Accessories

Termination resistor - PSI-TERMINATOR-PB-TBUS - 2702636



Active termination resistor for PROFIBUS and RS-485 bus systems, redundant power supply, routing of the supply voltage via DIN rail connector, electrical isolation, switchable termination, integrated programming interface

FO connectors - PSM-SET-FSMA/4-KT - 2799720



F-SMA plug set for polymer fiber, for self assembly consisting of 4 quick mounting connectors with bend protection sleeve

FO connectors - PSM-SET-FSMA/4-HCS - 2799487



F-SMA plug set for PCF fiber, for self assembly consisting of 4 quick mounting connectors with bend protection sleeve

DIN rail bus connectors - ME 17,5 TBUS 1,5/PP000-3,81 BK - 2890014

DIN rail connector for DIN rail mounting. Universal for TBUS housing. Gold-plated contacts, 2-pos.

Assembly tool - PSM-POF-KONFTOOL - 2744131



Polymer fiber DIY case, consisting of: Stripping knife, stripping pliers, polishing wheels for F-SMA and SC-RJ quick mounting connectors, polishing pad and emery paper

FO converters - PSI-MOS-PROFIB/FO 660 E - 2708290

Accessories

Assembly tool - PSM-HCS-KONFTOOL - 2799526



PCF assembly kit for F-SMA quick mounting connectors, including stripping blade, stripping pliers, aramide yarn scissors, fiber stripper, microscope, fiber cleaving tool for standard HCS fibers, four F-SMA connectors for standard PCF fibers, and documentation

Assembly tool - PSM-SET-FSMA-POLISH - 2799348



Polymer fiber polishing set, for F-SMA quick mounting connectors

Measuring instrument - PSM-FO-POWERMETER - 2799539



Fiber optic measuring case, consisting of an optical power meter, F-SMA, B-FOC adapters, reference fibers and operating instructions

Fiber optic coupling - PSM-SET-FSMA-LINK/2 - 2799416



Coupling; set consisting of 2 couplings for connecting F-SMA plugs

Stripping tool - PSM-STRIP-FC/PROFIB - 2744623



Quick stripping tool for PROFIBUS cable, type Fast Connect
